



## LCD and 16-Zone LED Keypads



1689  
16-Zone LED Keypad



1641  
LCD Keypad

### User's Manual



## **TABLE OF CONTENTS**

---

<b>1.0 INTRODUCTION .....</b>	<b>3</b>
<b>2.0 BASIC OPERATION .....</b>	<b>4</b>
2.1 Keypad Indicator Lights .....	4
2.2 Visual Feedback .....	5
2.3 Auditory Feedback .....	6
2.4 Alarm Memory Display .....	7
2.5 Event List (For Spectra 1641 LCD Keypad Only) .....	8
2.6 Trouble Display .....	9
2.7 Partitioning .....	13
<b>3.0 PROGRAMMING ACCESS CODES .....</b>	<b>14</b>
3.1 System Master Code (Default: 123456) .....	14
3.2 Master Codes .....	14
3.3 Duress Code .....	15
3.4 Programming Access Codes .....	15
<b>4.0 ARMING &amp; DISARMING .....</b>	<b>17</b>
4.1 Exit Delay .....	17
4.2 Disarming & Deactivating an Alarm .....	17
4.3 Regular Arming .....	18
4.4 Stay Arming .....	19
4.5 Force Arming .....	21
4.6 Manual Bypass Programming .....	22
4.7 One-Touch Arming .....	24
4.8 Keyswitch Arming .....	26
4.9 Auto-Arming .....	26

<b>5.0 ADDITIONAL FEATURES .....</b>	<b>28</b>
5.1 Programming Chime Zones .....	28
5.2 Keypad Muting .....	29
5.3 Panic Alarms .....	30
5.4 Program Time (clock) .....	30
5.5 PGM Button (Programmable Outputs) .....	31
5.6 Quick Function Keys .....	31
5.7 Keypad Settings (For LCD Keypads only) .....	32
<b>6.0 FIRE ALARMS .....</b>	<b>33</b>
<b>7.0 TESTING &amp; MAINTENANCE .....</b>	<b>37</b>
<b>8.0 SYSTEM CHECKLIST .....</b>	<b>38</b>
<b>9.0 APPENDIX A .....</b>	<b>44</b>

## **1.0 INTRODUCTION**

---

Thank you for selecting the ***Spectra Security System*** from **Paradox Security Systems**. The Spectra Security System will give you peace of mind by providing reliable security protection. Although, it can do much more than that. The Spectra System can realize your dreams of home automation such as controlling garage doors, lights, heating, temperature and much more. Consult your installer to take full advantage of your Spectra system's capabilities.

This advanced technology security system provides you with reliable security protection and powerful features that anyone can use without memorizing complex and confusing codes. The system consists of the Spectra Control Panel, one or more Spectra Keypads, various input devices (i.e. motion detectors, door contacts, etc.) and various output devices (i.e. bells, sirens, lights, etc.).

The elegant and user-friendly ***Spectra 1689 LED Keypad and 1641 LCD Keypads*** allow you to easily access your security system's functions and provide you with an easy-to-understand display of your security system's alarm and operational status. All the actions performed in your security system will be executed and displayed through the keypad. Therefore, before using your security system, we highly recommend you read this manual carefully and have your installer explain basic system operation to you.

## 2.0 BASIC OPERATION

The *Spectra 1689 LED and 1641 LCD Keypads* function in the same way, but display the visual feedback differently. This section will provide an overview of the keypads.



Many of the features in your system must be enabled by the installer. If the feature is not programmed, the keypad will emit a rejection beep and the action will be cancelled. Refer to “System Checklist” in section 8.0 for details.

### 2.1 KEYPAD INDICATOR LIGHTS

The state of each light on the *Spectra* Keypads represents a specific condition in your system as shown in Figure 2.1.

**Figure 2.1: Overview of Indicator Lights**

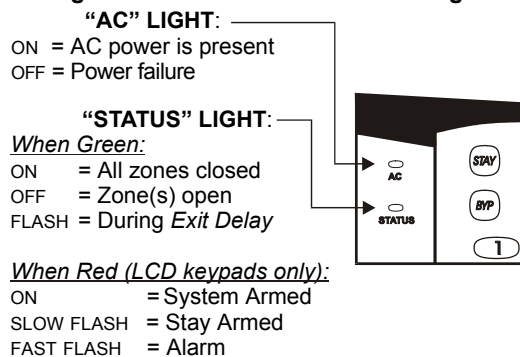

## 2.2 VISUAL FEEDBACK

### 2.2.1 For the Spectra 1689 LED Keypad

The numbers and symbols on the keypad's screen communicate your system's status as shown in Figure 2.2.

**Figure 2.2: Overview of the 1689 LED Keypad**

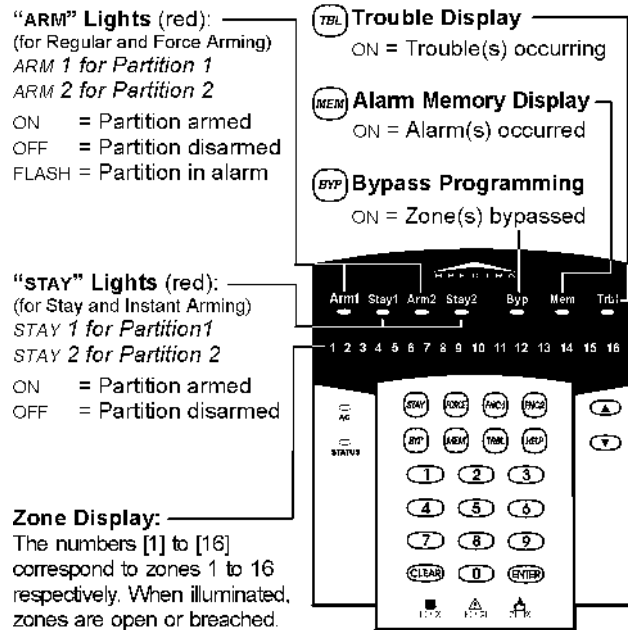

### 2.2.2 For the Spectra 1641 LCD Keypad

The LCD (liquid crystal display) is a 32-character screen that displays messages that can be customized to your needs.

**Figure 2.3: Overview of the 1641 LCD Keypad**

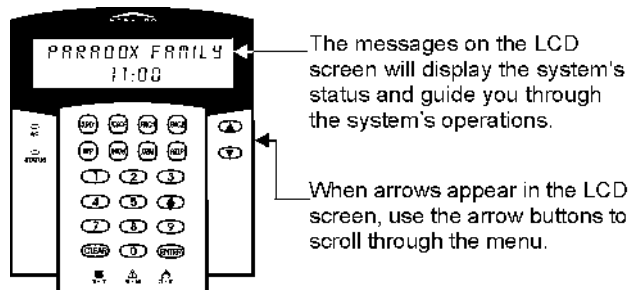

## 2.3 AUDITORY FEEDBACK

When you enter information on the keypad, it will guide you with beep tones. You should be familiar with these:

**Confirmation Beep:** When an operation (i.e. arming/disarming) is successfully entered on the keypad or when the system switches to a new status/mode, the keypad produces an intermittent beep tone ("BEEP-BEEP-BEEP-BEEP").

**Rejection Beep:** When the system reverts to previous status or when an operation is incorrectly entered on the keypad, it will emit a continuous beep tone ("BEEEEEEEEP").

## 2.4 ALARM MEMORY DISPLAY

---

All zones where alarms have occurred will be stored in memory. The system will erase the contents of the Alarm Memory every time the system is armed.

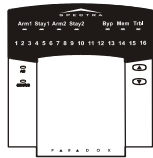

**For Spectra 1689 LED Keypad:** If an alarm has occurred on a zone, the [MEM] symbol will illuminate. After disarming the system, press the [MEM] button to illuminate the number symbols corresponding to the zones that were in alarm. To exit the *Alarm Memory Display*, press the [CLEAR] button.



**For Spectra 1641 LCD Keypad:** If an alarm has occurred on a zone, “Zone(s) in Memory [MEM] to view” will appear on the LCD screen. After disarming the system, press the [MEM] button. Use the [▲] or [▼] buttons to view the zones that were in alarm. To exit the *Alarm Memory Display*, press the [CLEAR] button.



## 2.5 EVENT LIST (For Spectra 1641 LCD Keypad Only)

The Event List will record all the actions that occur in the system.

How do I view the Event List?

- 1) Press the **[MEM]** button
- 2) Press the **[FNC2]** button
- 3) Use the **[▲]** or **[▼]** buttons to view the Event Screens
- 4) Press **[CLEAR]** twice to exit

Each event that occurs generates two Event Screens (see Figure 2.4). Once you enter the Event List, the time the event occurred and what event occurred will scroll on the screen. As you press the **[▼]** button, the next pair will scroll.

**Figure 2.4: Example of Event Screens**

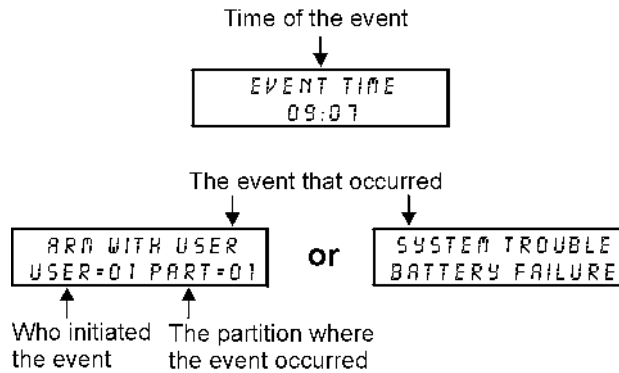

## 2.6 TROUBLE DISPLAY

Your alarm system continuously monitors fourteen possible trouble conditions. Most of these trouble conditions can be reported directly to your Security Company.



**We strongly suggest that you inform your Security Company of the trouble and allow them to service your system.**



The keypad can be programmed to emit a “BEEP” every 5 seconds whenever a new trouble condition has occurred. Press the [TRBL] button to stop the “Trouble Beep”.

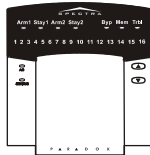

**For Spectra 1689 LED Keypad:** When a trouble condition occurs, the [TRBL] symbol will illuminate.

How Do I Access the Trouble Display?

- 1) Press the [TRBL] button  
*The [TBL] symbol will flash and number(s) corresponding to the trouble(s) will illuminate.*
- 2) Read the corresponding explanation of the trouble from the Trouble List. If no repair instructions are given, call your Security Company for repairs.
- 3) Press the [CLEAR] button to exit

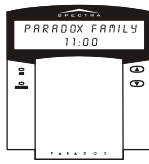

**For Spectra 1641 LCD Keypad:** When a trouble condition occurs, “System Trouble [TRBL] to View” will appear on the screen.

How Do I Access the Trouble Display?

- 1) Press the [TRBL] button  
“Trouble View System Trouble” will appear on the screen
- 2) Use the [▲] or [▼] buttons to view the Trouble(s). Read the corresponding explanation from the Trouble List. If no repair instructions are given, call your Security Company for repairs.
- 3) Press the [CLEAR] button to exit

### Trouble List

After you press the [TRBL] button:

On the **Spectra 1689 LED Keypad** the numbers [1] to [16] will illuminate for the corresponding trouble(s). On the **Spectra 1641 LCD Keypad** the heading(s) will appear on the screen.

#### [1] No or Low Battery Trouble

The backup battery is disconnected or the battery voltage is getting low.

#### [2] Wireless Transmitter Battery Low

The battery voltage in one or more Wireless Transmitters is getting low. Also, the device’s yellow light will flash.

**[3] Power Failure**

The system has detected a loss of AC power. This trouble usually occurs during a power failure. If a power failure is not occurring in your establishment and this trouble appears, contact your Security Company for service.

**[4] Bell/PGM2 Disconnected Trouble**

Any device connected to the Bell or PGM2 output is no longer connected to your alarm system.

**[5] Bell Current Failure**

During an alarm, the bell output, which uses a fuseless circuit, will automatically shut down if the current exceeds a predetermined value. When the system is disarmed, the current is cut from the bell output and the Trouble warning may extinguish, but the Trouble may re-occur during the next alarm if the situation is not corrected.

**[6] Auxiliary Current Failure**

The auxiliary output, which supplies power to your alarm system's accessories, uses a fuseless circuit to protect the power supply against current overload and automatically shuts down if the current exceeds a predetermined value.

**[7] Communication Failure**

Your alarm system, if monitored, could not communicate with the Security Company.

**[8] Timer Loss**

Your alarm system's clock must be re-programmed. **This is the only trouble that we recommend that you correct.**

**To re-program the clock** press the **[8]** button after Step 2 from the Trouble Display (see *"How Do I Access the Trouble Display?"* at the beginning of section 2.6) and enter the current time using the 24-hour clock (i.e. 8:30PM = 20:30). Also, see *Appendix A*.

**[9] Tamper/Zone Wiring Failure**

A wiring problem is occurring on one or more zones.

**To view which zones are experiencing trouble**, press the **[9]** button after Step 2 from the Trouble Display (see *"How Do I Access the Trouble Display?"* at the beginning of section 2.6).

**[10] Telephone Line Monitoring Failure**

The system has not detected the presence of a telephone line for more than 30 seconds.

**[11] Fire Zone Trouble**

A wiring problem on the fire zone is occurring.

**[12] Module Loss**

A module is no longer communicating with your system.

### **[13] Wireless Transmitter Supervision Loss**

A wireless transmitter is no longer communicating with its receiver or its batteries are disconnected..

**To view on which zones the Wireless Transmitters are experiencing trouble**, press the [MEM] button after Step 2 from the Trouble Display (see “*How Do I Access the Trouble Display?*” at the beginning of section 2.6).

### **[16] Keypad Fault**

If for any reason your keypad is no longer communicating with your alarm system, the keypad will emit four consecutive beeps at 3-second intervals. Press any button on the keypad to terminate the “beeping” sequence. When communication is restored, the keypad will resume its functions.

## **2.7 PARTITIONING**

---

Your **Spectra** system is equipped with a partitioning feature that can divide your alarm system into two distinct areas identified as Partition 1 and Partition 2. Partitioning can be used in installations where shared security systems are more practical, such as a home office or warehouse building. When partitioned, each zone, each User Code and many of your system's features can be assigned to either Partition 1, Partition 2, or both partitions.



***If the system is not partitioned, all zones, User Codes, and features will be recognized as belonging to Partition 1.***

## **3.0 PROGRAMMING ACCESS CODES**

Access Codes are personal identification numbers that allow you to enter certain programming modes, arm or disarm your system as well as activate or deactivate PGMs.

The **Spectra** security system supports the following:

- 1 *System Master Code*
- 2 *Master Codes*
- 45 *User Access Codes* (including 1 Duress code)

For information on how each *Access Code* can arm or disarm the system refer to the *System Checklist* in section 8.0.

### **3.1 SYSTEM MASTER CODE (Default: 123456)**

The *System Master Code* can arm or disarm any partition using any of the methods described in this section and can create, modify or delete any *User Access Code* (see section 3.4).

### **3.2 MASTER CODES**

*Master Code 1* is permanently assigned to Partition 1 and can be used to create, modify or delete *User Access Codes* (see section 3.4) that are assigned to Partition 1.

*Master Code 2* is permanently assigned to Partition 2 (except when partitioning is disabled, *Master Code 2* will be assigned to Partition 1) and can be used to create, modify or delete

*User Access Codes* (see section 3.4) that are assigned to the same partition.



Master Codes cannot modify or delete User Access Codes assigned to both partitions. Only the System Master Code can modify or delete User Access Codes assigned to both partitions.

### **3.3 DURESS CODE**

---

If you are forced to arm or disarm your system, entering the *Access Code* assigned to *User 048* will arm or disarm the system and immediately transmit a silent alert (Duress Code) to the Security Company.



Must be enabled by your installer.

### **3.4 PROGRAMMING ACCESS CODES**

---

Your system can use either 4- or 6-digit Access Codes (see page 39), where each digit can be any value from 0 to 9. Six-digit codes are considered more difficult to “crack” and therefore, more secure. Avoid programming simple or obvious access codes, such as your telephone number, address or codes such as 1234.



How Do I Program Access Codes?

- 1) Press **[ENTER]**
- 2) Enter your **[MASTER CODE]**
- 3) Enter 3-digit **[SECTION]** (see Table 1)
- 4) Enter a new 4- or 6-digit **[ACCESS CODE]**
- 5) Press **[CLEAR]** to exit

How Do I Delete Access Codes?

- 1) Repeat steps 1 to 3 (see above)
- 2) Press the **[FORCE]** button once for each digit in the Access Code (4 or 6 times) until the keypad emits a "CONFIRMATION BEEP" then press the **[CLEAR]** button to exit.

For *Spectra 1689 LED Keypad* also refer to *Appendix A*.

**Table 1: User Code Sections**

Section	User Codes
[001]	User Code 001 = <i>System Master Code</i>
[002]	User Code 002 = <i>Master Code 1</i>
[003]	User Code 003 = <i>Master Code 2</i>
[004] to [047]	<i>User Code 004 to User Code 047</i>
[048]	<i>User Code 048 or Duress Code</i>

## 4.0 ARMING & DISARMING

---

Take full advantage of your **Spectra** system by familiarizing yourself with all the arming methods.



If your system is not partitioned (section 2.7), everything is considered as belonging to Partition 1.

### 4.1 EXIT DELAY

---

After entering a valid arming sequence, an *Exit Delay Timer* will provide you with enough time to exit the protected area before the system arms. The keypad may beep during the Exit Delay.

### 4.2 DISARMING & DEACTIVATING AN ALARM

---

To disarm an armed system or an alarm, enter your access code. An entry point, like the front door, will be programmed with one of two *Entry Delay Timers*. When an entry point is opened, the keypad will beep until you disarm the system. Your alarm system will not generate an alarm until this timer elapses. Any user can disarm a partition they have been assigned to, except users assigned with the *Arm Only Option*. To disarm alarms generated by a *Delayed Fire Zone*, please refer to section 6.0..

How Do I Deactivate an Alarm?

Enter your **[ACCESS CODE]**

#### How Do I Disarm the System?

For a Stay or Instant Armed system, go to Step 2.

- 1) Enter through a designated entry point (i.e. front door).
- 2) Enter your **[ACCESS CODE]**

IF YOU HAVE ACCESS TO BOTH PARTITIONS (see section 2.7):

- 3) Press the button corresponding to the desired partition, **[1]** or **[2]**. For both partitions, press the other button after the confirmation beep.

### 4.3 REGULAR ARMING

---

This method will arm all the zones in the selected partition.

#### How Do I Regular Arm?

- 1) Close all zones in the desired partition.
- 2) Enter your **[ACCESS CODE]**

IF YOU HAVE ACCESS TO BOTH PARTITIONS (see section 2.7):

- 3) Press the button corresponding to the desired partition, **[1]** or **[2]**. For both partitions, press the other button after the confirmation beep.

Please note that *Regular Arming* can also be activated using *Auto-Arming* (see section 4.9), a *Keyswitch* (see section 4.8), or *One-Touch Arming* (see section 4.7).

#### 4.4 STAY ARMING

---

This method allows you to remain in the protected area while partially arming the system. Stay Zones are zones that are bypassed when Stay Arming. For example, when you go to sleep at night, doors and windows can be armed without arming other zones like motion detectors.

How Do I Stay Arm?

- 1) Close all zones in the desired partition (except *Stay Zones*).
- 2) Press the **[STAY]** button
- 3) Enter your **[ACCESS CODE]**

IF YOU HAVE ACCESS TO BOTH PARTITIONS (see section 2.7):

- 4) Press the button corresponding to the desired partition, **[1]** or **[2]**. For both partitions, press the other button after the confirmation beep.

*Stay Arming* can also be activated using *Auto-Arming* (see section 4.9), a *Keyswitch* (see section 4.8) or *One-Touch Arming* (see section 4.7).

#### **4.4.1 Instant Arming**

**After *Stay Arming*** the system and **during its *Exit Delay***, press and hold the **[STAY]** button for 3 seconds. You should hear a confirmation beep. The system is then *Instant Armed*. Therefore, any armed zone that is breached will immediately generate an alarm.

##### **If you have access to both partitions:**

To Instant Arm one partition

- 1) Press the **[STAY]** button
- 2) Enter your **[ACCESS CODE]**
- 3) Choose a partition
- 4) Press and hold the **[STAY]** button for 3 seconds

To Instant Arm both partitions

- 1) Press the **[STAY]** button
- 2) Enter your **[ACCESS CODE]**
- 3) Press **[1]**
- 4) Press **[2]**
- 5) Press and hold the **[STAY]** button for 3 seconds

## 4.5 FORCE ARMING

---

*Force Arming* allows you to rapidly arm the system without waiting for all zones in the system to close. During *Force Arming*, a *Force Zone* is considered “deactivated” until it closes, then the system will arm that zone. *Force Arming* is commonly used when a motion detector is protecting the area occupied by a keypad. For example, when arming and the motion detector is a *Force Zone*, the system will allow you to arm even if the zone is open.

How Do I Force Arm?

- 1) Close zones in the desired partition (except *Force Zones*).
- 2) Press the **[FORCE]** button
- 3) Enter your **[ACCESS CODE]**

IF YOU HAVE ACCESS TO BOTH PARTITIONS (see section 2.7):

- 4) Press the button corresponding to the desired partition, **[1]** or **[2]**. For both partitions, press the other button after the confirmation beep.

*Force Arming* can also be activated by using *One-Touch Force Arming* (see section 4.7.6).

## 4.6 MANUAL BYPASS PROGRAMMING

*Manual Bypass Programming* allows you to program the alarm system to ignore (deactivate) specified zones the next time the system is armed. For example, you may wish to bypass certain zones when workers are renovating part of your establishment. Once the system is disarmed, the bypass entries are erased.

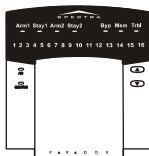

**For Spectra 1689 LED Keypad:** When zones are bypassed, the **[BYP]** symbol will illuminate.

### How Do I Bypass Zones?

- 1) Press the **[BYP]** button
- 2) Enter your **[ACCESS CODE]** (see Note 1, p. 23)
- 3) Illuminate the number(s) corresponding to the zone(s) you want to bypass by entering the two-digit zone number (i.e. zone 3 = 03)
- 4) Press the **[ENTER]** button to save and exit.

*Manual Bypass Programming* can also be activated by using *One-Touch Bypass Programming* (see section 4.7.7). To remove the Bypass feature from a zone, in Step 3 enter the zone number again or press **[FORCE]** to erase all current entries.

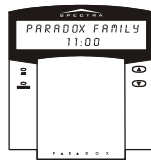

**For Spectra 1641 LCD Keypad:** When zones are bypassed, “Zone(s) Bypassed [BYP] to View” will appear on the screen.

#### How Do I Bypass Zones?

- 1) Press the [BYP] button
- 2) Enter your [ACCESS CODE] (see Note 1)
- 3) Enter the two-digit zone number of the desired zone (i.e. zone 3 = 03) or use the [▲] or [▼] buttons to view the zones and press the [BYP] button when the desired zone appears on the screen.
- 4) Press the [ENTER] button to exit

To remove the Bypass feature from a zone, in Step 3 re-enter the two-digit zone number of the desired zone or press the [BYP] button when the bypassed zone appears on the screen.

**NOTE1:** If you have access to both partitions, press the button corresponding to the desired partition, [1] or [2].

#### 4.6.2 Bypass Recall Feature

After disarming the system, the bypass entries are erased. The *Bypass Recall Feature* reinstates the previous bypass entries saved in memory. This eliminates the need to manually re-program the bypass entries every time you arm the system.



How Do I Recall Bypass Entries?

- 5) Press the **[BYP]** button.
- 6) Enter your **[ACCESS CODE]** (see Note1, p. 23).
- 7) Press the **[BYP]** button.
- 8) Press the **[ENTER]** button.

## **4.7 ONE-TOUCH ARMING**

---

*One-Touch Arming* allows you to arm the system without using an access code.

### **4.7.3 One-Touch Regular Arming**

Press and hold the **[ENTER]** button for 3 seconds (see Note1, p. 23) to arm all zones in the partition. You can use this feature to allow specific individuals like service personnel (i.e. cleaners) to arm without giving them access to any other alarm system operations. For details on *Regular Arming*, refer to section 4.3.

### **4.7.4 One-Touch Stay Arming**

Press and hold the **[STAY]** button for 3 seconds (see Note1, p. 23) to arm all zones not defined as *Stay Zones*. For details on *Stay Arming*, refer to section 4.4.

### **4.7.5 Fast Exit**

**WHEN THE SYSTEM IS ALREADY STAY ARMED:** this feature will allow you to exit already armed premises and keep the system armed.

**Exit and Stay Arm:** Press and hold the **[STAY]** button for 3 seconds (see Note1, p. 23) to start the *Exit Delay* (see section 4.1). When the *Exit Delay* elapses, the system will return to *Stay Arming*.

**Exit and Regular Arm:** Press and hold the **[ENTER]** button for 3 seconds (see Note1, p. 23) to start the *Exit Delay* (see section 4.1). When the *Exit Delay* elapses, the system will switch to *Regular Arming* (see section 4.3).

**Exit and Force Arm:** Press and hold the **[FORCE]** button for 3 seconds (see Note1, p. 23) to start the *Exit Delay* (see section 4.1). When the *Exit Delay* elapses, the system will switch to *Force Arming* (see section 4.5).

#### **4.7.6 One-Touch Force Arming**

Press and hold the **[FORCE]** button for 3 seconds (see Note1, p. 23) to bypass any open *Force Zones*. For details on *Force Arming*, refer to section 4.5.

#### **4.7.7 One-Touch Bypass Programming**

Press and hold the **[BYP]** button for 3 seconds (see Note1, p. 23) to access *Bypass Programming Mode* (see section 4.6).

## **4.8 KEYSWITCH ARMING**

---

A keyswitch can be used to arm and disarm the system. A keyswitch is programmed to *Stay Arm* (see section 4.4) or *Regular Arm* (see section 4.3) and is assigned to a specific partition. A keyswitch can function as a Maintained or Momentary keyswitch.

To arm the system using a Maintained Keyswitch, set the keyswitch to the “on” position. To disarm the system set the keyswitch to the “off” position.

To arm the system using a Momentary Keyswitch, set the keyswitch to the “on” position then turn it back to the “off” position. Repeating this sequence will disarm the system.

## **4.9 AUTO-ARMING**

---

The ***Spectra*** alarm system can be programmed to automatically arm upon the following two conditions.

### **4.9.8 Timed Auto Arming**

You can program the time your alarm system will automatically arm itself everyday.

How do I program the Auto-Arm Timer?

- 1) Press the [ENTER] button
- 2) Enter your [MASTER CODE]
- 3) Enter [101] for Partition 1 or [102] for Partition 2
- 4) Enter the desired [TIME]  
*Example: 6:15PM = 18:15*

**For Spectra 1689 LED Keypad** also refer to **Appendix A**.



A 60-second Exit Delay (see section 4.1) will start before the system arms. At this point, Auto-Arming can be cancelled by entering your access code.

#### **4.9.9 “No Movement” Auto Arming**

Your panel can be programmed to arm the system and/or send a report if no zone activity occurs for a pre-programmed amount of time. This is a particularly useful feature when supervising an individual with chronic health problems or who lives alone.

## 5.0 ADDITIONAL FEATURES



Each keypad must be Chimed and Muted separately. Chime Zones and Keypad Muting must be re-programmed if your system suffers a total power loss.

### 5.1 PROGRAMMING CHIME ZONES

A *Chime Enabled* zone will advise you every time it is opened by causing your keypad to beep.

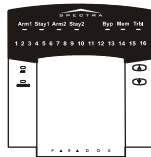

#### For Spectra 1689 LED Keypad:

##### How Do I Chime Zones?

- 1) Press & hold the **[9]** button for 3 seconds
- 2) Illuminate the numbers corresponding to the zones you want to Chime by entering the two-digit zone number. For example, to Chime zone 2 enter **[0]** then **[2]**.
- 3) Press the **[ENTER]** button to save & exit.

To remove the Chime feature from a zone, in Step 2 enter the zone number again so the number extinguishes or press **[FORCE]** to remove Chiming from all zones programmed to Chime. When you program Chime Zones, once you press and hold the **[9]** button the **[ARM1]**, **[STAY1]**, **[ARM2]**, **[STAY2]**, **[BYP]**, **[MEM]**, and **[TRBL]** symbols will flash. Any zones that are already Chimed will also illuminate. Zones that remain off or extinguished are not Chimed.

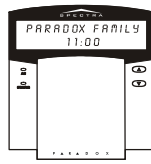

### For Spectra 1641 LCD Keypad:

#### How Do I Chime Zones?

- 1) Press & hold the **[9]** button for 3 seconds
- 2) Enter the two-digit zone number of the desired zone or use the **[▲]** or **[▼]** buttons to view the zones and press the **[FNC1]** button when the desired zone appears on the screen.
- 3) Press the **[ENTER]** button to save & exit

To remove the Chime feature from a zone, in Step 3 re-enter the two-digit zone number of the desired zone (i.e. to remove Chime from zone 2, enter **[0]** then **[2]**) or press the **[FNC1]** button when the bypassed zone appears on the screen.

## 5.2 KEYPAD MUTING

When muted, the keypad will only emit the confirmation beep, rejection beep, and beep when a button is pressed. Therefore, when muted, the keypad will not beep during an alarm. Press and hold the **[CLEAR]** button for 3 seconds to enable or disable Keypad Muting. If the keypad emits a confirmation beep, Keypad Muting is enabled for that keypad. If the keypad emits a rejection beep, the feature is disabled.

### 5.3 PANIC ALARMS

---

In case of emergency, the **Spectra** system can provide three panic alarms that can immediately generate an alarm after simultaneously pressing and holding two specific buttons for three seconds. Based on your needs, these panic alarms can generate audible alarms (sirens or bells) or silent alarms and can communicate specific messages to your monitoring station. For instance, pressing **[1]** & **[3]** can mean “call the police” or anything you require.

Press & hold buttons **[1]** and **[3]** for the police.

Press & hold buttons **[4]** and **[6]** for a medical alarm.

Press & hold buttons **[7]** and **[9]** for a fire alarm.

### 5.4 PROGRAM TIME (CLOCK)

---

How do I program the System Clock?

- 1) Press the **[ENTER]** button
- 2) Enter **[MASTER CODE]**
- 3) Enter **[100]**
- 4) Enter the desired **[TIME]**.  
*Example: 6:15PM = 18:15*
- 5) Press **[CLEAR]**

For **Spectra 1689 LED Keypad** also refer to **Appendix A**.

## **5.5 PGM BUTTON (PROGRAMMABLE OUTPUTS)**

---

Your **Spectra** system may include one or more programmable outputs (PGMs). When a specific event or condition occurs in the system, the PGM can be used to reset smoke detectors, activate light switches in your home or office, open/close garage doors and much more. A PGM can also be programmed to activate whenever the **[FNC1]** button is pressed and held for 3 seconds.

## **5.6 QUICK FUNCTION KEYS**

---

Upon request of your installer or Security Company you may have to perform one of the following. Press:

### **5.6.1 Test Report**

**[ENTER] + [MASTER CODE] + [MEM]**

If your system is monitored by your Security Company, this feature will send a test report code to the Security Company.

### **5.6.2 Call PC**

**[ENTER] + [MASTER CODE] + [BYP]**

Will initiate a call to the Security Company that is using the Winload software.

### **5.6.3 Answer PC**

**[ENTER] + [MASTER CODE] + [FORCE]**

Will force your security system to answer a call made by your Security Company that is using the Winload software.



#### **5.6.4 Cancel Communication**

**[ENTER] + [MASTER CODE] + [STAY]**

Cancels all communication with the Winload software if it has been initiated.

#### **5.7 KEYPAD SETTINGS** (For LCD Keypads only)

---

You can modify the keypad's setting to suit your needs.

- 1) Press & hold **[6]** for 3 seconds
- 2) Choose one. Press:
  - [1]** Backlight: the keypad's light (7 is the brightest)
  - [2]** Contrast: character intensity (7 is the lightest)
  - [3]** Scroll: time between messages (7 is slowest)
- 3) Press **[▲]** or **[▼]** to modify
- 4) Press **[ENTER]** to save
- 5) Return to step 2 or **[CLEAR]** to exit

## 6.0 FIRE ALARMS

---

Upon a fire alarm, the bell/siren will emit three “squawks” at 2 second intervals until silenced or reset by entering a valid access code. If the zone is a *Delayed Fire Zone*, there is a delay before the system contacts the Security Company. This will prevent unnecessary reporting of false alarms. If there is no fire condition, contact your Security Company immediately to avoid an unnecessary response.

What do I do if a Delayed Fire Zone was set off accidentally?

- 1) Press the **[CLEAR]** button within 30 seconds of the alarm.
- 2) Try to correct the problem.
- 3) If the problem persists, the alarm will sound again. Press **[CLEAR]** again.

These steps will instruct the system to delay reporting the fire alarm to the Security Company (see Figure 6.1 on page 34).

**Figure 6.1: Delayed Fire Zone Event Sequence**

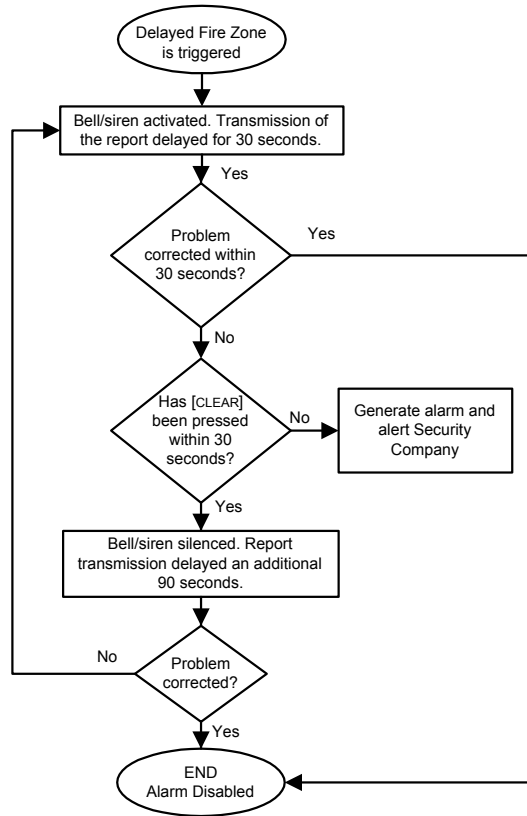

### **Minimizing Fire Hazards**

The three most common causes of fires:

- Cooking is the leading cause of home fires in the U.S. It's also the leading cause of fire injuries. Cooking fires often result from unattended cooking and human error, rather than mechanical failure of stoves or ovens.
- Careless smoking is the leading cause of fire deaths. Smoke detectors and smolder-resistant bedding and upholstered furniture are significant fire deterrents.
- Heating is the second leading cause of residential fires. However, heating fires are a larger problem in single family homes than in apartments since the heating systems in single family homes are often not professionally maintained.

### **Fire Safety Tips**

- In the event of a fire, remember time is the biggest enemy and every second counts! Escape first, then call for help. Develop a home fire escape plan and designate a meeting place outside. Make sure everyone in the family knows two ways to escape from every room. Practice feeling your way out with your eyes closed. Never stand up in a fire, always crawl low under the smoke and try to keep your mouth covered. Never return to a burning building for any reason; it may cost you your life.
- Finally, having at least one working smoke alarm dramatically increases your chances of surviving a fire. And remember to practice a home escape plan frequently with your family.

**Providing a Fire Warning System**

Household fires are especially dangerous at night. Fires produce smoke and deadly gases that can overcome occupants while they sleep. To warn against fire, smoke detectors should be installed outside each separate sleeping area in the immediate vicinity of the bedrooms and on each additional story of the family living unit, including basements.

## **7.0 TESTING & MAINTENANCE**

---

With the system disarmed and the “READY” Light on, activate motion detectors by walking in the protected area. Open and close protected doors and verify that the corresponding button illuminates. Your installer can advise you of the best way to test your particular system.

Do not use open flame or burning materials to test your fire detection devices. Contact your installer for safe methods of testing your system.

Under normal use, your system requires virtually no maintenance other than regular testing. It is recommended that the standby battery be changed every three years. Speak to your installer about the necessary tests and at what frequency they should be performed.

## 8.0 SYSTEM CHECKLIST

Zone Description

Is this system partitioned? Yes  No

Partition 1 =

---

Partition 2 =

---

Zone # and Description	Partition 1 or 2	Byp	Stay	Force	24Hr	Entry Delay
01: _____	_____	<input type="checkbox"/>	<input type="checkbox"/>	<input type="checkbox"/>	<input type="checkbox"/>	<input type="checkbox"/>
02: _____	_____	<input type="checkbox"/>	<input type="checkbox"/>	<input type="checkbox"/>	<input type="checkbox"/>	<input type="checkbox"/>
Keyswitch? Y <input type="checkbox"/> N <input type="checkbox"/>	_____	<input type="checkbox"/>	<input type="checkbox"/>	<input type="checkbox"/>	<input type="checkbox"/>	<input type="checkbox"/>
Type: _____						
03: _____	_____	<input type="checkbox"/>	<input type="checkbox"/>	<input type="checkbox"/>	<input type="checkbox"/>	<input type="checkbox"/>
Fire Zone? Y <input type="checkbox"/> N <input type="checkbox"/>	_____	<input type="checkbox"/>	<input type="checkbox"/>	<input type="checkbox"/>	<input type="checkbox"/>	<input type="checkbox"/>
Delayed? Y <input type="checkbox"/> N <input type="checkbox"/>	_____	<input type="checkbox"/>	<input type="checkbox"/>	<input type="checkbox"/>	<input type="checkbox"/>	<input type="checkbox"/>
04: _____	_____	<input type="checkbox"/>	<input type="checkbox"/>	<input type="checkbox"/>	<input type="checkbox"/>	<input type="checkbox"/>
05: _____	_____	<input type="checkbox"/>	<input type="checkbox"/>	<input type="checkbox"/>	<input type="checkbox"/>	<input type="checkbox"/>
06: _____	_____	<input type="checkbox"/>	<input type="checkbox"/>	<input type="checkbox"/>	<input type="checkbox"/>	<input type="checkbox"/>
07: _____	_____	<input type="checkbox"/>	<input type="checkbox"/>	<input type="checkbox"/>	<input type="checkbox"/>	<input type="checkbox"/>
08: _____	_____	<input type="checkbox"/>	<input type="checkbox"/>	<input type="checkbox"/>	<input type="checkbox"/>	<input type="checkbox"/>
09: _____	_____	<input type="checkbox"/>	<input type="checkbox"/>	<input type="checkbox"/>	<input type="checkbox"/>	<input type="checkbox"/>

Zone # and Description	Partition 1 or 2	Byp	Stay	Force	24Hr	Entry Delay
10: _____	_____	<input type="checkbox"/>	<input type="checkbox"/>	<input type="checkbox"/>	<input type="checkbox"/>	<input type="checkbox"/>
11: _____	_____	<input type="checkbox"/>	<input type="checkbox"/>	<input type="checkbox"/>	<input type="checkbox"/>	<input type="checkbox"/>
12: _____	_____	<input type="checkbox"/>	<input type="checkbox"/>	<input type="checkbox"/>	<input type="checkbox"/>	<input type="checkbox"/>
13: _____	_____	<input type="checkbox"/>	<input type="checkbox"/>	<input type="checkbox"/>	<input type="checkbox"/>	<input type="checkbox"/>
14: _____	_____	<input type="checkbox"/>	<input type="checkbox"/>	<input type="checkbox"/>	<input type="checkbox"/>	<input type="checkbox"/>
15: _____	_____	<input type="checkbox"/>	<input type="checkbox"/>	<input type="checkbox"/>	<input type="checkbox"/>	<input type="checkbox"/>
16: _____	_____	<input type="checkbox"/>	<input type="checkbox"/>	<input type="checkbox"/>	<input type="checkbox"/>	<input type="checkbox"/>

**Access Codes**

For security reasons, write only the user's name and not his or her access code. 4-Digit Codes  6-Digit Codes

User # and Name	Partition 1 or 2	Byp	Stay	Force	Arm Only	PGM Only
001: _____ System Master Code Default: <b>123456</b>	1 & 2	<input checked="" type="checkbox"/>	<input checked="" type="checkbox"/>	<input checked="" type="checkbox"/>	<input type="checkbox"/>	<input type="checkbox"/>
002: _____ Master Code 1	_____	<input type="checkbox"/>	<input type="checkbox"/>	<input type="checkbox"/>	<input type="checkbox"/>	<input type="checkbox"/>
003: _____ Master Code 2	_____	<input type="checkbox"/>	<input type="checkbox"/>	<input type="checkbox"/>	<input type="checkbox"/>	<input type="checkbox"/>
004: _____	_____	<input type="checkbox"/>	<input type="checkbox"/>	<input type="checkbox"/>	<input type="checkbox"/>	<input type="checkbox"/>
005: _____	_____	<input type="checkbox"/>	<input type="checkbox"/>	<input type="checkbox"/>	<input type="checkbox"/>	<input type="checkbox"/>



User # and Name	Partition 1 or 2	Byp	Stay	Force	Arm Only	PGM Only
006: _____	_____	<input type="checkbox"/>	<input type="checkbox"/>	<input type="checkbox"/>	<input type="checkbox"/>	<input type="checkbox"/>
007: _____	_____	<input type="checkbox"/>	<input type="checkbox"/>	<input type="checkbox"/>	<input type="checkbox"/>	<input type="checkbox"/>
008: _____	_____	<input type="checkbox"/>	<input type="checkbox"/>	<input type="checkbox"/>	<input type="checkbox"/>	<input type="checkbox"/>
009: _____	_____	<input type="checkbox"/>	<input type="checkbox"/>	<input type="checkbox"/>	<input type="checkbox"/>	<input type="checkbox"/>
010: _____	_____	<input type="checkbox"/>	<input type="checkbox"/>	<input type="checkbox"/>	<input type="checkbox"/>	<input type="checkbox"/>
011: _____	_____	<input type="checkbox"/>	<input type="checkbox"/>	<input type="checkbox"/>	<input type="checkbox"/>	<input type="checkbox"/>
012: _____	_____	<input type="checkbox"/>	<input type="checkbox"/>	<input type="checkbox"/>	<input type="checkbox"/>	<input type="checkbox"/>
013: _____	_____	<input type="checkbox"/>	<input type="checkbox"/>	<input type="checkbox"/>	<input type="checkbox"/>	<input type="checkbox"/>
014: _____	_____	<input type="checkbox"/>	<input type="checkbox"/>	<input type="checkbox"/>	<input type="checkbox"/>	<input type="checkbox"/>
015: _____	_____	<input type="checkbox"/>	<input type="checkbox"/>	<input type="checkbox"/>	<input type="checkbox"/>	<input type="checkbox"/>
016: _____	_____	<input type="checkbox"/>	<input type="checkbox"/>	<input type="checkbox"/>	<input type="checkbox"/>	<input type="checkbox"/>
017: _____	_____	<input type="checkbox"/>	<input type="checkbox"/>	<input type="checkbox"/>	<input type="checkbox"/>	<input type="checkbox"/>
018: _____	_____	<input type="checkbox"/>	<input type="checkbox"/>	<input type="checkbox"/>	<input type="checkbox"/>	<input type="checkbox"/>
019: _____	_____	<input type="checkbox"/>	<input type="checkbox"/>	<input type="checkbox"/>	<input type="checkbox"/>	<input type="checkbox"/>
020: _____	_____	<input type="checkbox"/>	<input type="checkbox"/>	<input type="checkbox"/>	<input type="checkbox"/>	<input type="checkbox"/>
021: _____	_____	<input type="checkbox"/>	<input type="checkbox"/>	<input type="checkbox"/>	<input type="checkbox"/>	<input type="checkbox"/>
022: _____	_____	<input type="checkbox"/>	<input type="checkbox"/>	<input type="checkbox"/>	<input type="checkbox"/>	<input type="checkbox"/>
023: _____	_____	<input type="checkbox"/>	<input type="checkbox"/>	<input type="checkbox"/>	<input type="checkbox"/>	<input type="checkbox"/>
024: _____	_____	<input type="checkbox"/>	<input type="checkbox"/>	<input type="checkbox"/>	<input type="checkbox"/>	<input type="checkbox"/>
025: _____	_____	<input type="checkbox"/>	<input type="checkbox"/>	<input type="checkbox"/>	<input type="checkbox"/>	<input type="checkbox"/>

User # and Name	Partition 1 or 2	Byp	Stay	Force	Arm Only	PGM Only
026: _____	_____	<input type="checkbox"/>	<input type="checkbox"/>	<input type="checkbox"/>	<input type="checkbox"/>	<input type="checkbox"/>
027: _____	_____	<input type="checkbox"/>	<input type="checkbox"/>	<input type="checkbox"/>	<input type="checkbox"/>	<input type="checkbox"/>
028: _____	_____	<input type="checkbox"/>	<input type="checkbox"/>	<input type="checkbox"/>	<input type="checkbox"/>	<input type="checkbox"/>
029: _____	_____	<input type="checkbox"/>	<input type="checkbox"/>	<input type="checkbox"/>	<input type="checkbox"/>	<input type="checkbox"/>
030: _____	_____	<input type="checkbox"/>	<input type="checkbox"/>	<input type="checkbox"/>	<input type="checkbox"/>	<input type="checkbox"/>
031: _____	_____	<input type="checkbox"/>	<input type="checkbox"/>	<input type="checkbox"/>	<input type="checkbox"/>	<input type="checkbox"/>
032: _____	_____	<input type="checkbox"/>	<input type="checkbox"/>	<input type="checkbox"/>	<input type="checkbox"/>	<input type="checkbox"/>
033: _____	_____	<input type="checkbox"/>	<input type="checkbox"/>	<input type="checkbox"/>	<input type="checkbox"/>	<input type="checkbox"/>
034: _____	_____	<input type="checkbox"/>	<input type="checkbox"/>	<input type="checkbox"/>	<input type="checkbox"/>	<input type="checkbox"/>
035: _____	_____	<input type="checkbox"/>	<input type="checkbox"/>	<input type="checkbox"/>	<input type="checkbox"/>	<input type="checkbox"/>
036: _____	_____	<input type="checkbox"/>	<input type="checkbox"/>	<input type="checkbox"/>	<input type="checkbox"/>	<input type="checkbox"/>
037: _____	_____	<input type="checkbox"/>	<input type="checkbox"/>	<input type="checkbox"/>	<input type="checkbox"/>	<input type="checkbox"/>
038: _____	_____	<input type="checkbox"/>	<input type="checkbox"/>	<input type="checkbox"/>	<input type="checkbox"/>	<input type="checkbox"/>
039: _____	_____	<input type="checkbox"/>	<input type="checkbox"/>	<input type="checkbox"/>	<input type="checkbox"/>	<input type="checkbox"/>
040: _____	_____	<input type="checkbox"/>	<input type="checkbox"/>	<input type="checkbox"/>	<input type="checkbox"/>	<input type="checkbox"/>
041: _____	_____	<input type="checkbox"/>	<input type="checkbox"/>	<input type="checkbox"/>	<input type="checkbox"/>	<input type="checkbox"/>
042: _____	_____	<input type="checkbox"/>	<input type="checkbox"/>	<input type="checkbox"/>	<input type="checkbox"/>	<input type="checkbox"/>
043: _____	_____	<input type="checkbox"/>	<input type="checkbox"/>	<input type="checkbox"/>	<input type="checkbox"/>	<input type="checkbox"/>
044: _____	_____	<input type="checkbox"/>	<input type="checkbox"/>	<input type="checkbox"/>	<input type="checkbox"/>	<input type="checkbox"/>
045: _____	_____	<input type="checkbox"/>	<input type="checkbox"/>	<input type="checkbox"/>	<input type="checkbox"/>	<input type="checkbox"/>

User # and Name	Partition 1 or 2	Byp	Stay	Force	Arm Only	PGM Only
046: _____	_____	<input type="checkbox"/>	<input type="checkbox"/>	<input type="checkbox"/>	<input type="checkbox"/>	<input type="checkbox"/>
047: _____	_____	<input type="checkbox"/>	<input type="checkbox"/>	<input type="checkbox"/>	<input type="checkbox"/>	<input type="checkbox"/>
048: _____	_____	<input type="checkbox"/>	<input type="checkbox"/>	<input type="checkbox"/>	<input type="checkbox"/>	<input type="checkbox"/>
Duress: Y <input type="checkbox"/> N <input type="checkbox"/>		_____				

**Special Buttons and Features**

- [ENTER] One-touch *Regular Arming* is activated
- [STAY] One-touch *Stay Arming* is activated
- [FORCE] One-touch *Force Arming* is activated
- [BYP] One-touch *Manual Bypass Programming* is activated

**Panic Alarms:**

- [1] & [3] Police or \_\_\_\_\_  Silent  Audible  Off
- [4] & [6] Aux. or \_\_\_\_\_  Silent  Audible  Off
- [7] & [9] Fire or \_\_\_\_\_  Silent  Audible  Off

**PGMs:**

PGM 1:

\_\_\_\_\_

PGM 2:

\_\_\_\_\_

PGM 3

\_\_\_\_\_

**System Timers**

Enter and exit your premises through the designated doors.

*Exit Delay 1* (Partition 1): \_\_\_\_\_ sec. = time to exit site

*Exit Delay 2* (Partition 2): \_\_\_\_\_ sec. = time to exit site

*Entry Delay 1* = \_\_\_\_\_ sec. = time to disarm before alarm;  
enter through zone # \_\_\_\_\_

*Entry Delay 2* = \_\_\_\_\_ sec. = time to disarm before alarm;  
enter through zone # \_\_\_\_\_

Alarm will activate siren or bell for \_\_\_\_\_ min.

**Other Information**

Installed by: \_\_\_\_\_ Date: \_\_\_\_\_

Serviced by: \_\_\_\_\_ Tel: \_\_\_\_\_

Monitored by: \_\_\_\_\_ Tel: \_\_\_\_\_

Your account number: \_\_\_\_\_

Alarm transformer location: \_\_\_\_\_ on  
circuit #: \_\_\_\_\_

Location of Telephone Connections:  
\_\_\_\_\_

## 9.0 APPENDIX A

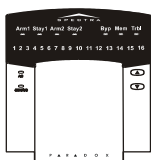

### **For Spectra 1689 LED Keypad only**

Do not read the following if you have not read these sections:

- *User Access Codes* (see section 3.4)
- *System's Clock* (see section 5.4)
- *Auto-Arm Time* (see section 4.9)

After entering the 3-digit section you wish to program, the **[ARM1]** and **[STAY1]** will flash. If a value is programmed, the number corresponding to the first digit of the programmed value will also illuminate. At this point, you can begin entering the required data. After entering a digit, the number corresponding to the following programmed digit will illuminate and so forth. For example, if you wish to change *User Code 004* from 123456 to 454545, after entering section **[004]**, number **[1]** will turn on. Press the **[4]** button and number **[2]** will turn on, then press the **[5]** button and number **[3]** will turn on...

OR

After entering the desired 3-digit section and before entering any data, press the **[ENTER]** button to access the *Data Display Mode*. The **[ARM1]** and **[STAY1]** Lights will illuminate. Once in the *Data Display Mode*, pressing the **[ENTER]** button will scroll through the digits of the current section and the **[BYP]**, **[MEM]** & **[TRBL]** Lights will flash. When viewing the last digit in the section, pressing the **[ENTER]** button will automatically advance to the next section. Press **[CLEAR]** to exit.

### **Warranty**

The Seller warrants its products to be free from defects in materials and workmanship under normal use for a period of one year. Except as specifically stated herein, all express or implied warranties whatsoever, statutory or otherwise, including without limitation, any implied warranty of merchantability and fitness for a particular purpose, are expressly excluded. Because Seller does not install or connect the products and because the products may be used in conjunction with products not manufactured by Seller, Seller cannot guarantee the performance of the security system. Seller obligation and liability under this warranty is expressly limited to repairing or replacing, at Seller's option, any product not meeting the specifications. In no event shall the Seller be liable to the buyer or any other person for any loss or damages whether direct or indirect or consequential or incidental, including without limitation, any damages for lost profits, stolen goods, or claims by any other party caused by defective goods or otherwise arising from the improper, incorrect or otherwise faulty installation or use of the merchandise sold.

**P ▲ R ▲ D ○ X®**  
**S E C U R I T Y S Y S T E M S**  
[www.paradox.ca](http://www.paradox.ca)

PRINTED IN CANADA - 08/02  
SPEKEL-04